



Educator's Depot, Inc.

Phone : (866) 736-2012

Email : customerservice@educatorsdepot.com

17424 W. Grand Pkwy
Sugarland, TX 77479

www.educatorsdepot.com

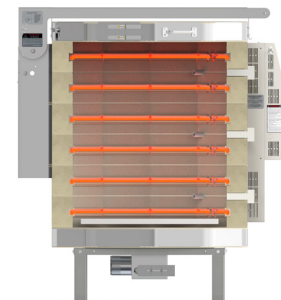

SCHOOL KILN CATALOG



Hear from a Pro

Time, Efficiency, Reliability

“ After 20 years in the kiln repair business, I can say that L&L kilns last longer than other brands, and the cost of ownership is much lower. General maintenance like replacing elements can be done in half the time of most other brands, and they typically need fewer repairs because they are so durable. **That can add up to a savings of several hundred dollars per kiln per year.** ”

-Neil Estrick -
20+ years of kiln repair

Hard Channels



Protect Your Brick



Why Teach Ceramics?

Impacts on Student Learning

Improve	May Reduce	Encourage	
<ul style="list-style-type: none"> ● Problem-Solving Skills ● Hand-Eye Coordination ● Fine Motor Skills ● Focus 	<ul style="list-style-type: none"> ● Anxiety ● Depression ● PTSD ● Anger 	<ul style="list-style-type: none"> ● Self Expression ● Curiosity ● Self-Discipline 	<ul style="list-style-type: none"> ● Story-Telling ● Communication ● Social Skills

Accessible For All

Inclusive Education

Sensory Stimulation: Working with clay and ceramics involves tactile experiences, which can provide sensory stimulation. For individuals with learning disabilities, this hands-on activity may help in managing hyperactivity and improving focus.



Wedging To Remove Air



Wheel Throwing



Trimming & Defining Forms



Hand-building



Painting & Glazing Forms

Core Skills Impact

Beyond Fine Motor Skills

STEM Skills	Language Skills	Cross-Curriculum
<ul style="list-style-type: none"> ● Geometry ● Measurements ● Fractions ● Patterns & Symmetry ● Chemistry 	<ul style="list-style-type: none"> ● Storytelling & Writing ● Vocabulary Development ● Presentation Skills ● Symbolism & Metaphor 	<ul style="list-style-type: none"> ● Spark Student Engagement ● Diverse Learning Styles

Easy for Teachers

Be a Pro

Touch-Screen Control

- Simple, Intuitive Interface
- Phone App To Monitor
- Pre-Programmed Firings
- Customizable Options



Genesis Touchscreen Video Guides

[hotkilns.com/
support/videos](http://hotkilns.com/support/videos)

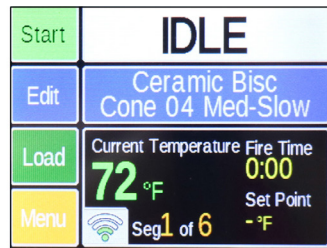

Genesis 2.0 with KilnAid app

Manufactured by Bartlett Instruments for L&L Kiln Mfg., Inc.

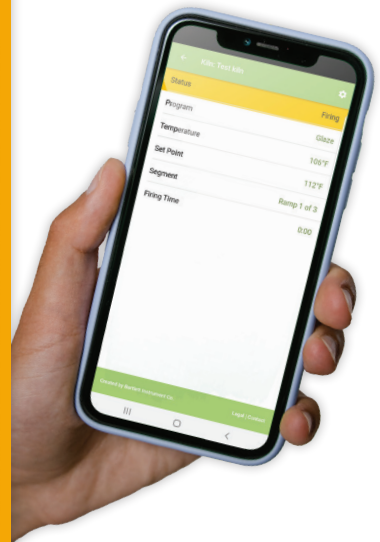

"These kilns keep looking new for decades because of the element holders. Now with the zone control, they fire absolutely evenly from top to bottom. All of this excellent engineering, along with their reasonable prices, make L&L the best electric kiln on the market."

- Lisa Orr - lisaorr.com



Easy to Load

Features for Durability

- Spring Assist Lid
- Strong Kiln Furniture
- Protected Thermocouples
- Protected Brick



- Protected Thermocouples & Firebrick = Save \$\$\$

Easy to Troubleshoot

Time = Money, Save Both

Easy Maintenance

- Easy Element Changes
- Clean, Trouble-Free Interior
- Easy Trouble-Shooting
- Automatic Firing Logs

L&L Solutions

- Hard Ceramic Channels
- Self-Supporting Panels
- Ceramic Terminals
- Insulated Controls
- Quick-Ship Parts
- Online Parts Database
- Quick, Expert Service
- Instructional Videos



No Expertise Needed

In-House Maintenance

No other kiln manufacturer places so much emphasis on easy and safe maintenance. This can be crucial not just for artists but for schools and institutions - because you will save time and money and keep your program running smoothly. L&L has unique features, like self-supporting, hands-free control panels, labeled wiring, hard channels, and no-crimp element connections to make it easy and possible for in-house maintenance personnel, without kiln expertise, to maintain your kilns.

Easy to Fix

Time = Money, Save Both

- 1 Hard Ceramic Element Channels
- 2 Straight-View Peephole Plugs
- 3 Protected Thermocouples
- 4 "No Crimp" Element Connections
- 5 Full-Support Stand
- 6 Genesis Touch Screen Control
- 7 Automatic Zone Control (on most models)
- 8 Easy-Open Spring Hinge
- 9 Easy Service Control Panel

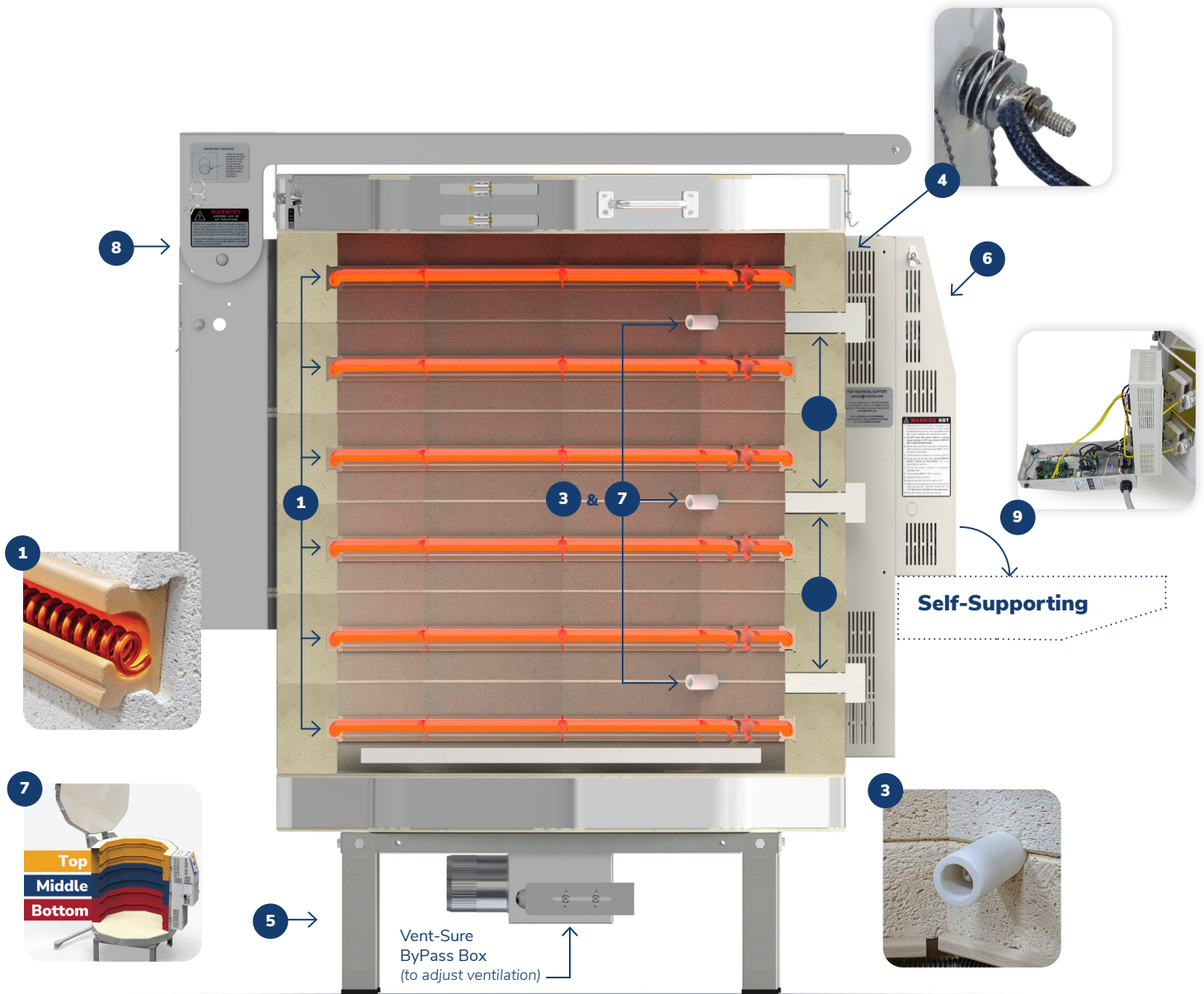

* When Vent Is Ordered

Elementary & Middle

For Low-Fire Programs

See hotkilns.com/SM23T-3 for all features and options

School-Master SM23T-3

Standard L&L Features

- Genesis Mini Touch Screen Control • with Kiln Aid app
- Hard Ceramic Element Channels • protect your elements and kiln
- Type K Thermocouple (1) • with protection tube
- 3" • K23 Brick
- Top Loading • Spring assisted lid
- Solid, Straight-View Peephole Plugs
- Full-Support Stand • rolling option available
- Easy-Access Control Panel • with Easy-View tilted display
- c-MET-us listed to UL499 Standards

Unique to School-Master

- Designed for Low Fire (Cone 1) • Max Cone 6 (2232°F)
- Multi-Voltage • (208v - 240v)
- Five-Year Limited Warranty
- Single Zone • graded elements for uniformity



School-Master Package

- 1 - School-Master Kiln
- 1 -Vent-Sure Downdraft Vent System
- 1 - Furniture Kit
- 1 - Vent Controller



SM23T-3 Package

School-Master Package
hotkilns.com/SM23T-3-Package

L&L Model Comparisons

School-Master vs e23T-3 vs e28S-3

Model No.	No. Shelves F=full, H=half	Inside Diam	Inside Height	Cubic Feet	Exterior Dim (in)	240/1 KW~Amp~Fuse	240/3 KW~Amp~Fuse	208/1 KW~Amp~Fuse	208/3 KW~Amp~Fuse	Lbs Kiln	Lbs w/Kit
SM23T-3-A	20" (8H)	22.3"	27"	6.7	30W x 68H x 40D	11.5~48.0~60	11.5~27.8~40	9.0~43.2~60	9.0~27.9~40	380	470
e23T-3	20" (8H)	22.3"	27"	6.7	30W x 68H x 40D	11.5~48.0~60	11.5~27.7~40	10.0~48.0~60	11.0~30.5~40	380	470
e28S-3	25-1/2" (6H)	28"	18"	6.8	35W x 65H x 46D	11.5~47.9~60	11.5~41.5~60	10.0~48.0~60	10.0~41.6~60	410	520

See the kiln pages for other voltages

SM23T-3 & e23T-3 Kiln Capacity

Example: 6" Diam x 3" Height Bowl
Approximately 38 Bowls

SM23T-3

- **Temp Rating: Cone 1 (6 Max)**
- **Volume: 6.7 Cubic Feet**
- **Brick Thickness: 3" Brick**
- **Inside: 22.3" Diam x 27" H**

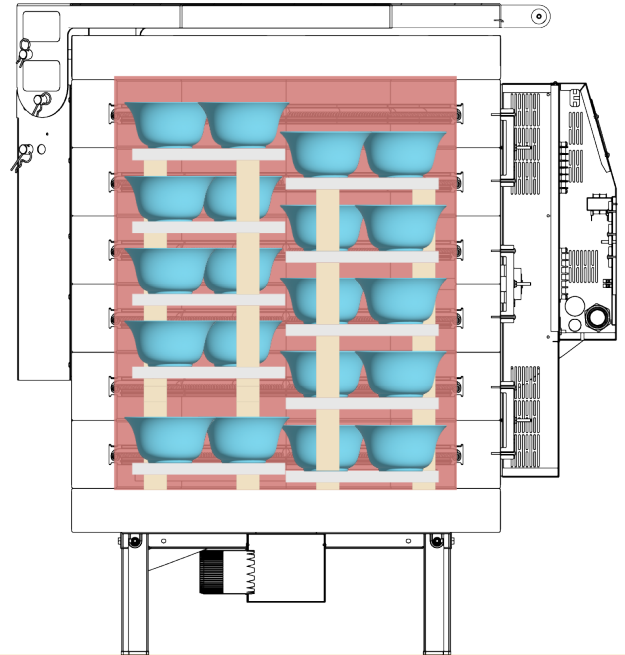
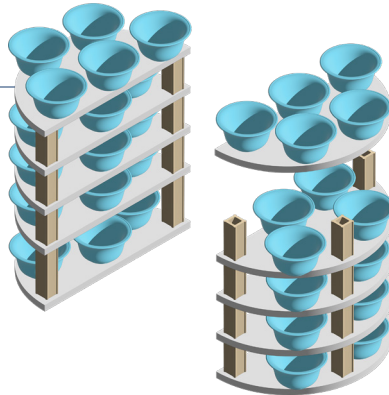

Alternatives to School-Master For More Advanced Programs

Easy-Fire e23T-3 hotkilns.com/e23T-3-Package

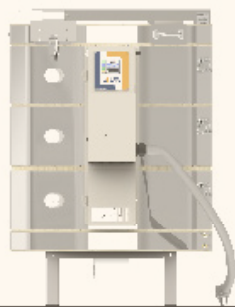

e23T-3 Package



- **Temp Rating: Cone 10**
- **Volume: 6.7 Cubic Feet**
- **Brick Thickness: 3" Brick**
- **Inside: 22.3" Diam x 27" H**
- **Capacity: Approx 38 Bowls (6" Diam x 3" H)**

Easy-Fire e28S-3 hotkilns.com/e28S-3-Package

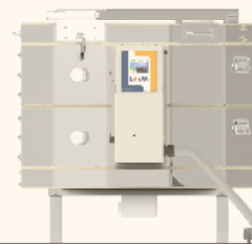

e28S-3 Package



- **Temp Rating: Cone 10**
- **Volume: 6.8 Cubic Feet**
- **Brick Thickness: 3" Brick**
- **Inside: 28" Diam x 18" High**
- **Capacity: Approx 50 Bowls (6" Diam x 3" H)**

Advanced Middle School and High School

See hotkilns.com/eQ2827-3 for all features and options

eQuad Pro Kilns (3 Sizes Available)

Model Shown: eQ2827-3

- Genesis Touch Screen Control • with Kiln Aid app
- Dynamic Zone Control • for even firing
- Hard Ceramic Element Channels • protect your elements and kiln
- Type K Thermocouples (3) • with protection tubes
- 3" • K23 Brick
- Top Loading • spring assisted lid
- Solid, Straight View Peephole Plugs
- Full-Support Stand • rolling option available
- Easy-Access Control Panel • branch fusing included
- Three-Year Limited Warranty
- c-MET-us listed to UL499 Standards

Unique to eQuad-Pro

- Quad Element System Comes Standard
 - for extra long element life
- Cone 10 (2350°F) • with extra power



eQ2827-3 Package

- 1 - eQ2827-3
- 1 - Vent-Sure Downdraft Vent System
- 1 - Furniture Kit
- 1 - Vent Controller



**eQ2827-3
Package**

eQ2827 Package
hotkilns.com/eQ2827-3-Package

L&L Model Comparisons

e28M-3 vs e28T-3 vs eQ2827-3

Model No.	No. of Shelves All Half Shelves	Inside Diam	Inside Height	Cubic Feet	Exterior Dimensions	240/1 KW~Amp~Fuse	240/3 KW~Amp~Fuse	208/1 KW~Amp~Fuse	208/3 KW~Amp~Fuse	Lbs Kiln	Lbs w/Kit
e28M-3	25-1/2" (6H)	28"	22.5"	8.5	35W x 69H x 46D	11.5~48.0~60	16.6~40.0~50	10.0~48.0~60	14.3~39.8~50	445	555
e28T-3	25.5" (8H)	28"	27"	10.2	35W x 74H x 46D	11.5~48.0~60	16.6~40.0~50	10.0~48.0~60	14.3~39.8~50	475	610
eQ2827-3	25.5" (8H)	28"	27"	10.2	35W x 74H x 49D	15.0~62.3~80	15.0~36.0~50	15.0~71.9~90	15.0~41.5~60	515	650

See the kiln pages for other voltages

e28T-3 & eQ2827-3 Kiln Capacity

Example: 6" Diam x 3" Height Bowl
Approximately 74 Bowls

eQ2827-3

- Temp Rating: Cone 10
- Volume: 10.2 Cubic Feet
- Brick Thickness: 3" Brick
- Inside: 28" Diam x 27" H

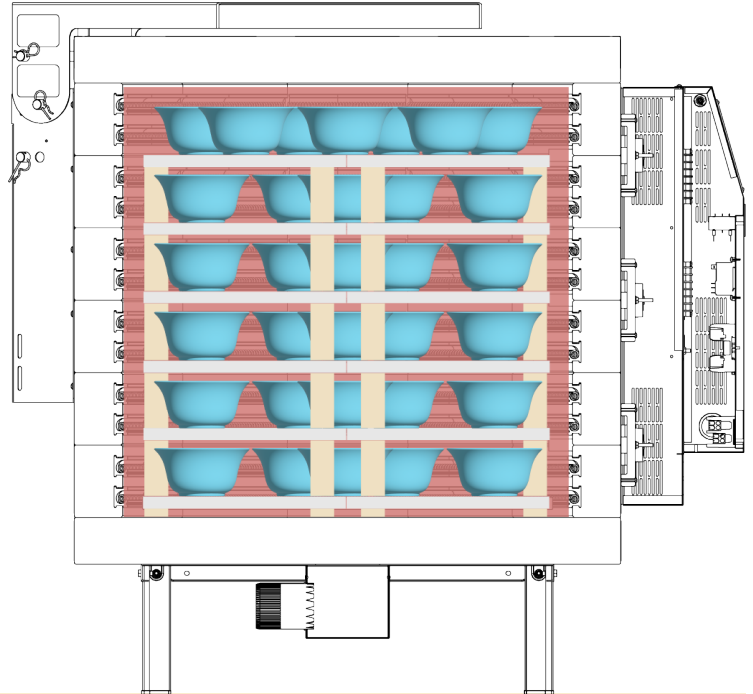
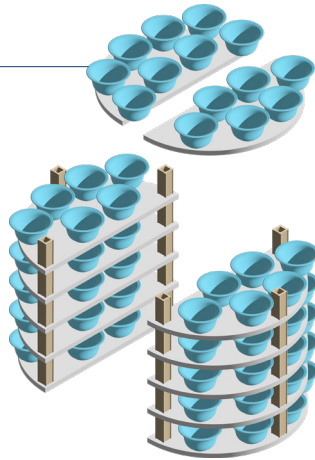

Alternatives to eQ2827-3

Cost, Size, & Power Alternatives

Easy-Fire e28M-3 hotkilns.com/e28M-3-Package

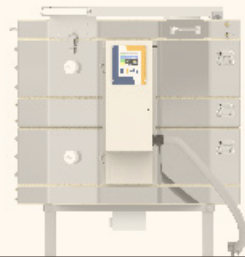

e28M-3 Package



- Temp Rating: Cone 10 (Cone 8 on 208V/1Ph)
- Volume: 8.5 Cubic Feet
- Brick Thickness: 3" Brick
- Inside: 28" Diam x 22.5" H
- Capacity: Approx 62 Bowls (6" Diam x 3" H)

Easy-Fire e28T-3 hotkilns.com/e28T-3-Package

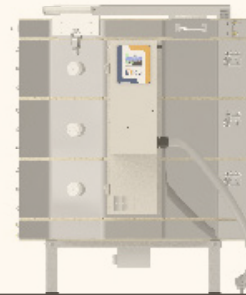

e28T-3 Package



- Temp Rating: Cone 10 on 3-phase models
Cone 8 on 240V/1Ph
Cone 5 on 208V/1Ph
- Volume: 10.2 Cubic Feet
- Brick Thickness: 3" Brick
- Inside: 28" Diam x 27" H
- Capacity: Approx 74 Bowls

eFL Front-loading Kilns (3 Sizes Available)

Model Shown: eFL2635

- **Genesis Touch Screen Control** • with Kiln Aid app
- **Dynamic Zone Control** • for even firing
- **Hard Ceramic Element Channels**
protect your elements and kiln
- **Cone 10 (2350°F)**
- **Type K Thermocouples (3)**
• with protection tubes
- **Solid, Straight-View Peephole Plug**
- **Easy-Access Control Panel**
- **Three-Year Limited Warranty**
- **c-MET-us listed to UL499 Standards**

Unique to eFL Series

- **3" • K23 Brick** • balanced front to back with micro-porous backup insulation in door and K25 brick in the back • eliminates the need for door elements
- **Front-Loading**
- **Door Switch** • for safety



eFL2635 Package

- 1 - eFL2635
- 1 - Vent-Sure D downdraft Vent System
- 1 - Furniture Kit
- 1 - Vent Controller



**eFL2635
Package**

eFL2635 Package
hotkilns.com/eFL2635-Package

L&L Model Comparisons

eFL2635 vs Davinci T2327

Model Number	Kiln Shelves	Cubic Feet	Inside Height	Inside Dimensions	Exterior Dimensions	240/1 KW-Amp-Fuse	240/3 KW-Amp-Fuse	208/1 KW-Amp-Fuse	208/3 KW-Amp-Fuse	Lbs Kiln	Lbs w/Kit
eFL2635	(8) 12" x 24"	13.7	35"	26W x 35H x 26D	45W x 72H x 39D	19.2-80.0-100	19.2-52.9-70	19.2-92.3-125	19.2-61.1-80	895	900
T2327	(9) 22" x 11"	14.4	27"	34.75W x 27H x 26.5D	68W x 84H x 47D	19.5-81.3-100	19.5-46.9-60	19.5-93.8-125	19.5-54.2-70	1035	1170

See the kiln pages for other voltages

eFL2635 Kiln Capacity

Example: 6" Diam x 3" Height Bowl
Approximately 128 Bowls

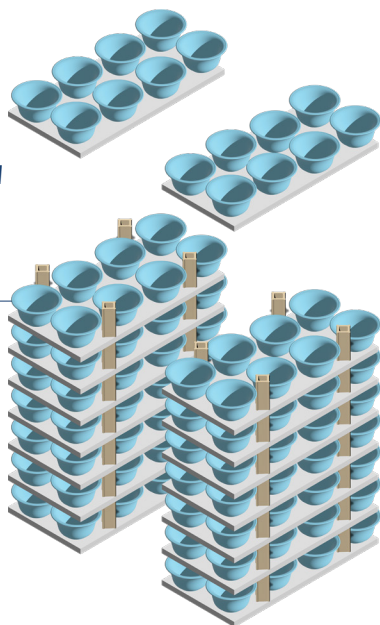

eFL2635

- **Temp Rating: Cone 10**
- **Volume: 13.7 Cubic Feet**
- **Inside Dimensions: 26" W x 35" H x 26" D**

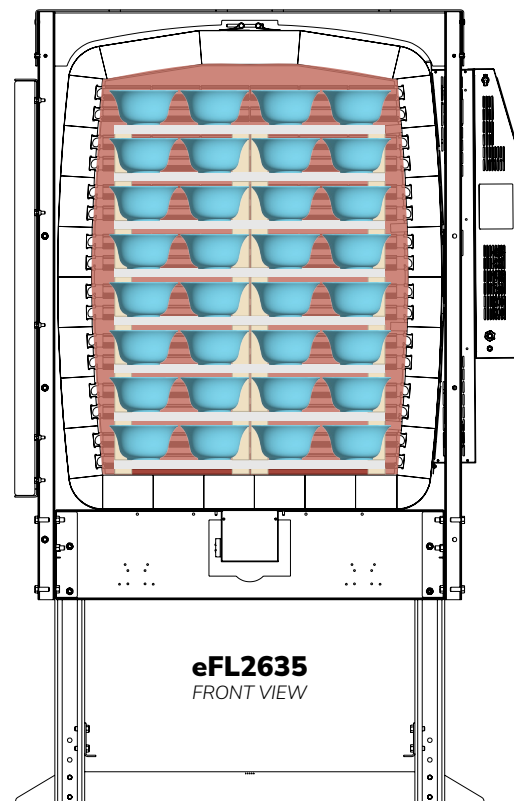

Alternative to eFL Series

Cost, Size, & Power Alternative

Davinci T2327 hotkilns.com/T2327-Package



**T2327
Package**

Davinci T2327 Package



- **Temp Rating: Cone 10**
- **Volume: 14.4 Cubic Feet**
- **Brick Thickness: 3" Brick**
- **Inside: 34.75W x 27H x 26.5D**
- **Capacity: Approx 108 Bowls (6" Diam x 3" H)**

	BRAND	MODEL	CU FT	MAX CONE
Easy-Fire E23T-3 6.7 CU FT CONE 10 School-Master SM23T-3-A 6.7 CU FT CONE 6	SKUTT	KM1027-3	6.40	10
	PARAGON	TNF24-3	7.10	10
	OLYMPIC	2327E	7.00	8
	CRESS	E27	7.00	10
	EVENHEAT	RM II 2329	7.50	8
	AMACO	EX-270SF	7.00	10
Easy-Fire E28S-3 6.8 CU FT CONE 10	SKUTT	KMT-1218	6.6	10
	OLYMPIC	2818HE	6.67	10
	CRESS	ET2818-208	6.6	10
	EVENHEAT	HF 2918	7	10
	AMACO	EX-1266SF	6.6	10
	CONE ART	2818D	6.66	10
Easy-Fire E28M-3 8.5 CU FT CONE 10	SKUTT	KM1222-3	8.10	10
	PARAGON	TNF27-3	8.11	10
	OLYMPIC	2823HE	8.34	10
	AMACO	EX-381SF	8.10	10
	JEN-KEN	AF 2431	8.11	8
	EVENHEAT	RM II 2922	8.70	8
	CONE ART	2822D	8.33	10
Easy-Fire E28T-3 10.2 CU FT CONE 10	SKUTT	KM1227-3	9.90	8
	PARAGON	TNF28-3	10.57	5
	OLYMPIC	2827E	10.00	8
	CRESS	ET28	9.92	10
	JEN-KEN	AF 2829 3"	10.33	8
	EVENHEAT	RM II 2929	11.30	8
	CONE ART	BX-2827D	10.00	10
eQuad-Pro EQ2827-3 10.2 CU FT CONE 10	SKUTT	KM1227-3PK	9.90	10
	PARAGON	VIKING-28	10.57	10
	OLYMPIC	2827HE	10.00	10
	EVENHEAT	HF2927	10.50	10
	AMACO	EX-1099SF	9.92	10
Front-Loading eFL2635 13.7 CU FT CONE 10	PARAGON	DRAGON	9.00	10
	OLYMPIC	FL12E	12.00	10
Davinci T2327 14.4 CU FT CONE 10	PARAGON	JANUS OVATION	11.40	10
	OLYMPIC	2531HE	14.80	10
	EVENHEAT	RM II 2541	14.40	03
	JEN-KEN	AF OVAL 27	14.00	8
	SKUTT	KM-1627-3PK	18.50	10

Unparalleled Safety

Features & Highlights of L&L Kilns

Durable, Safe, Efficient

Features	L&L Kilns	Other Kiln Brands
Integrated Vent System <i>Attached Directly to the Kiln Stand</i>	<input checked="" type="checkbox"/>	Vent Box, Supported From Floor, Can Come Loose
Hard Ceramic Element Channels	<input checked="" type="checkbox"/>	Routed Into Fragile Firebrick, Element Changes Can Cause Brick Damage
Easy Access Control Panel <i>Self-Supporting for Solo Maintenance</i>	<input checked="" type="checkbox"/>	Often Difficult To Work On, Requires An Expert
Fully Supported Stand	<input checked="" type="checkbox"/>	Typically Are Thin Gauge With No Center Support
Safety Guides	<input checked="" type="checkbox"/>	<input checked="" type="checkbox"/>

Hard Channels Protect Your Brick

Only On L&L Kilns



Reduced Costs

Maintenance & Time Savings

Features	L&L Kilns	Other Kiln Brands
Hard Ceramic Element Channels <i>Protect Your Elements and Increase Longevity</i>	<input checked="" type="checkbox"/>	Not Available
Protected Thermocouples <i>Protect From Loading Damage</i>	<input checked="" type="checkbox"/>	Not Available
Pin-Free Elements <i>Save Time & Brick Integrity</i>	<input checked="" type="checkbox"/>	Time Consuming & Damages Brick
Quick Element Changes <i>Save Time & Money</i>	<input checked="" type="checkbox"/>	Requires More Care & Expertise
Warranty Included <i>With Purchase</i>	3-5 Year	3 Month - 2 Year
Thermocouples Included <i>In Warranty</i>	<input checked="" type="checkbox"/>	Varies

Ventilation

PRO TIP: Install a room thermometer approximately 6 ft away from the kiln and 6ft off the floor. The room temperature should be 90° F or less when firing.

VENTING KILNS: WHY AND HOW?

Cracking the kiln lid for manual venting is outdated and can be hazardous. Firing clay and glazes produces fumes like carbon, carbon monoxide, sulphur, and water vapor. Powered kiln vents are crucial to safeguard your kiln and pottery, removing these fumes efficiently.

THE VENT-SURE DOWNDRAFT VENT

Unlike other systems, this vent **attaches directly to the kiln stand**. It also enhances kiln uniformity, extends element life, and improves glaze colors by maintaining a vacuum for fumes and keeping the motor away from kiln heat.

ROOM HEAT VENTILATION MATTERS

In addition to kiln venting, a room vent or window is key. Aim for 10-25 times the kiln's cubic feet per hour.

CONTROL YOUR VENTING WITH A VENT CONTROL

Opt for our vent control system to manage venting during the firing process. Most fumes are produced at specific times. A vent control allows you to minimize air vented from the kiln and room until specific times in the firing cycle.

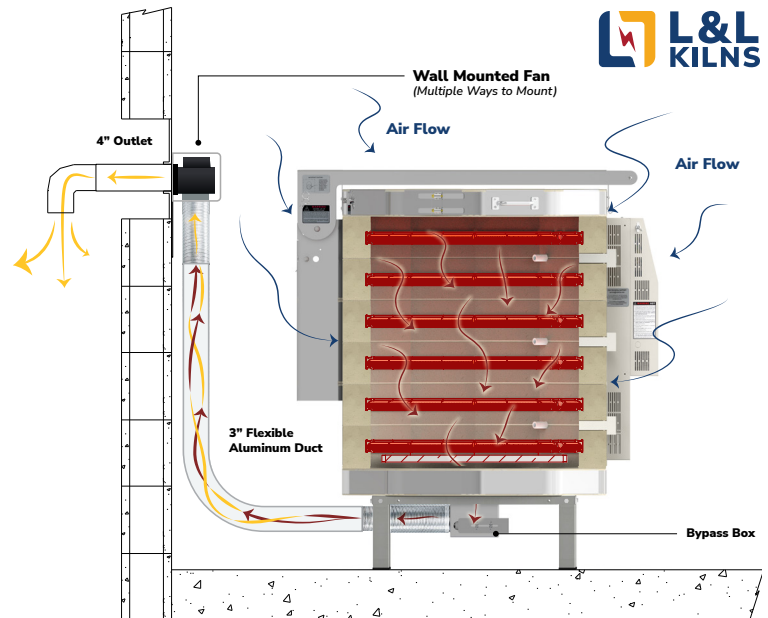

Vent-Sure Downdraft Vent System

Vent Box Attached To Stand

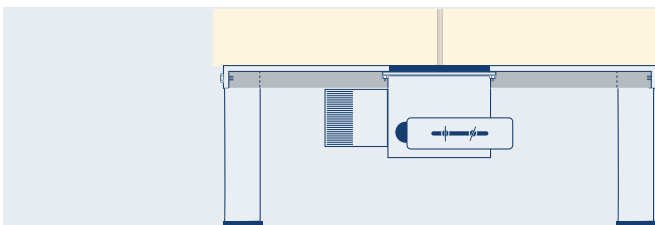

Vent Box Supported From Floor

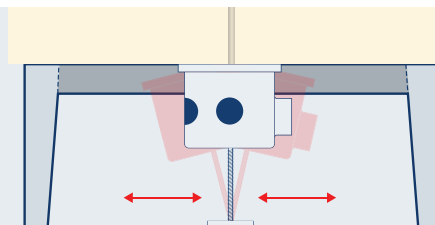

Top View



L&L Kiln Stands

Full center- kiln base support with integrated bolts for direct mounting vent bypass box to the kiln stand. Adjustable slide allows for airflow control.

Other Brands

Stands typically have no center . Vent is supported by a single foot that needs the floor for support. Any movement can release the seal.

Top View



Maintenance & Durability



CONSIDER MAINTENANCE COSTS

Opt for a kiln designed for easy maintenance. Schools can save time and money due to L&L Kilns unique durability and maintenance features because our kilns are designed for non-experts to maintain. Schools can find savings without the high cost of scarce kiln repair technicians.

COMMON ISSUES IN OTHER KILNS

In most electric kilns, elements in soft firebrick grooves deteriorate over time. Pins, often used for support, can damage the kiln. A single mishap with a kiln shelf can permanently harm the element groove.

PINS AMPLIFY ISSUES

Pins, expanding and contracting differently from brick, worsen firebrick fractures.

L&L SOLUTIONS

L&L's hard ceramic element channels extend kiln life by safeguarding firebrick during changes and accidents. No pins are needed, allowing elements to expand freely, reducing strain and extending their life. Element changes are quick and require no special tools, with no kiln disassembly or difficult crimping.

Hard Channels



Protect Your Brick

No Element Pins



Long-Lasting, Clean Interior

Dense Ceramic Element Channels

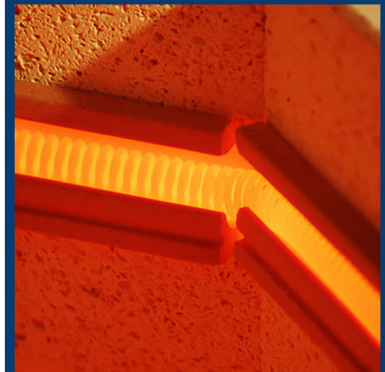

Increase Radiating Surface Of Elements

Installation Checklist

Fillable Form

See hotkilns.com for all features and options

Voltage & Power

USA VOLTAGE

Kilns are in 240 or 208 volts, single/three-phase. Household voltage is 240V single phase; institutions may have 208V, 480V, or three-phase. Confirm with an electrician.

ENERGY SAVINGS?

No savings for different voltages/phases.

480V MODELS

L&L offers 28" Jupiter, eFL, DaVinci, and Easy-Load kilns in 480V.

WRONG KILN VOLTAGE = IMPROPER OPERATION RESULTS

A 240V kiln loses 25% on 208V; a 208V kiln on 240V draws excess power, tripping the breaker. If you mistakenly order the wrong voltage or phase, replacing the elements and power cord is a straightforward process on an L&L kiln.

INTERNATIONAL VOLTAGES

Outside the USA, it's typically 220V single-phase or 380V three-phase. L&L provides special elements for both at no extra cost, and all models work on 50 or 60 Hz.

VOLTS _____

PHASE _____ (single vs three phase)

CIRCUIT BREAKER _____ AMPS

DISTANCE FROM BREAKER _____ Feet

See each kiln's electrical specs to see which plug is standard to your kiln:

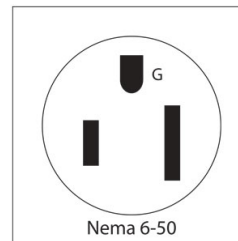

Typical Single Phase
50 Amp Cord

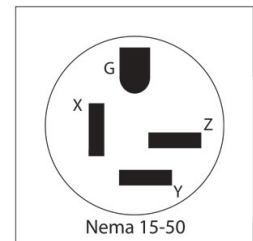

Typical Three Phase
50 Amp Cord

Kiln Size Needed

Determine Kiln Capacity for School Projects

[Detailed Description Here](http://hotkilns.com/choosing-school-kiln)
hotkilns.com/choosing-school-kiln



Average Project Size	Number of Students	Firings Per Week	Kiln Sizes										
<p>(4 in x 4 in x 6 in) 1728 in</p>	<p>= 1.3 Cubic Feet</p>	<p>4 Firings Per Week 64/4 = 16 cu ft per firing</p> <table border="1"> <tr> <td>Mon</td> <td>Tues</td> <td>Wed</td> <td>Thur</td> <td>Fri</td> </tr> <tr> <td></td> <td></td> <td></td> <td></td> <td></td> </tr> </table>	Mon	Tues	Wed	Thur	Fri						<p><u>16 cu ft per firing</u></p> <p>Option A: One - e23T-3 = 6.7 cu ft One - e28T-3 = 10.2 cu ft</p> <p>Option B: Two- e28M-3 = 8.5 cu ft</p>
	Mon		Tues	Wed	Thur	Fri							
<p>48 Students between two classrooms</p> <p>48 x 1.3 per student = 64 cu ft</p>													

Installation Checklist

Fillable Form

CSI Specifications:

hotkilns.com/support/pdfs/sample-csi-specifications



SPACE CONSIDERATIONS

CLEARANCES, LOADING & OPERATING

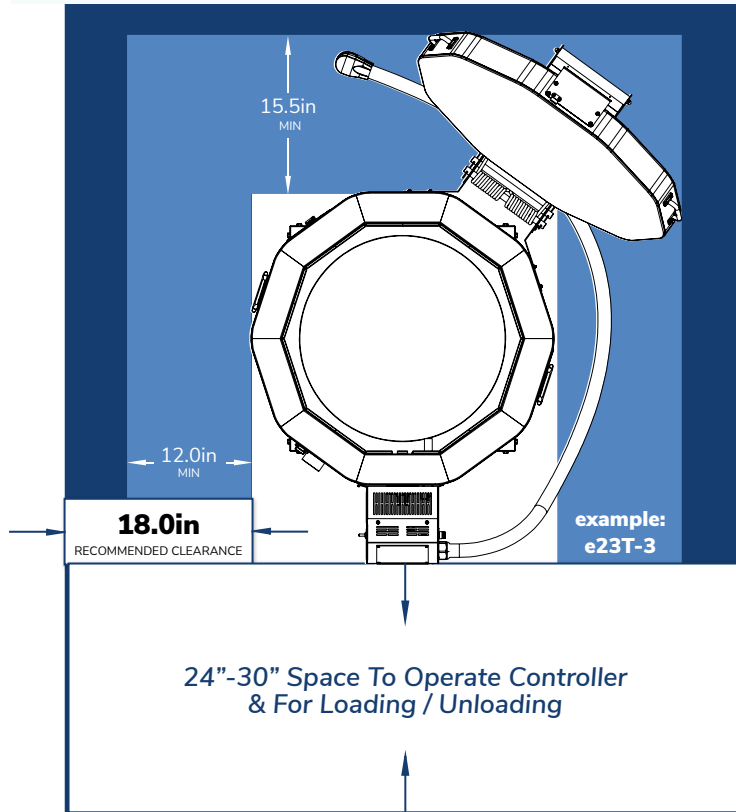

Read CSI Specifications

- CSI specification outlines the requirements for kilns in school facilities, emphasizing safety and compliance. It covers design, materials, quality assurance, product specifications, and installation guidelines. The document highlights the importance of proper examination, preparation, and cleaning for optimal performance and longevity of the equipment.

Child Safety

- Children will be protected from the hot kiln.
- Kiln room that locks or a secure designated space.
- Post Signage
"Hot Kiln - DO NOT TOUCH"
"No Students Allowed", etc.
- If possible, "Caution" floor tape to map out a safe area.

Heat Safety

- Recommended 18" from any wall (12" MIN)
- Kiln room floor is non-flammable
- Dedicated "Class C" fire extinguisher
- Sprinkler system for the kiln room (Optional)
- 24"-30" clearance for controls & loading

Ventilation

- Room fan or HVAC sized for the heat of kiln
(See hotkilns.com/calculate-venting)
- Downdraft Vent to remove fumes

L&L Kiln Mfg Inc

Founded in 1945, L&L is the oldest school kiln manufacturer in the United States.

**Family Owned & Operated
For Over 75 Years**

L&L focuses exclusively on designing and building the most durable line of electric kilns made today with innovative engineering, superior technical support, and quick, efficient service.



Craft/Test
Kilns

School-Master
Kilns

Easy-Fire
Kilns

eQuad-Pro
Kilns

Davinci Square &
Rectangular Kilns

Studio Front-
Loading Kilns

Commercial Front-
Loading Kilns



See all L&L School Kilns
hotkilns.com/school-kilns



L&L Kiln Mfg Inc
505 Sharptown Rd
Swedesboro, NJ 08085

Toll Free: 800-750-8350
Phone No: (856) 294-0077
Email: info@hotkilns.com